

**RoHS**  
COMPLIANT

◆ SPECIFICATIONS

- Current rating: 2A AC, DC
- Voltage rating: 250V AC,DC
- Temperature range: -40°C ~ +105°C
- Insulation resistance: 1000MΩ Min.
- Withstanding voltage: 800V AC/ minute.
- Contact resistance: 20mΩ Max.

Material: Nylon 66 UL 94V-0

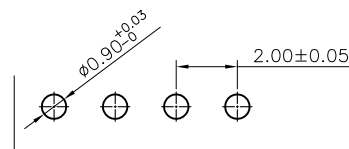
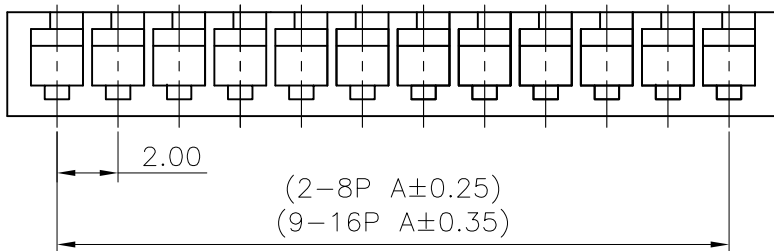
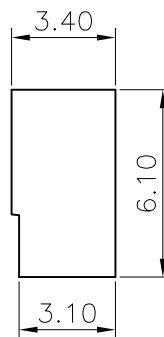
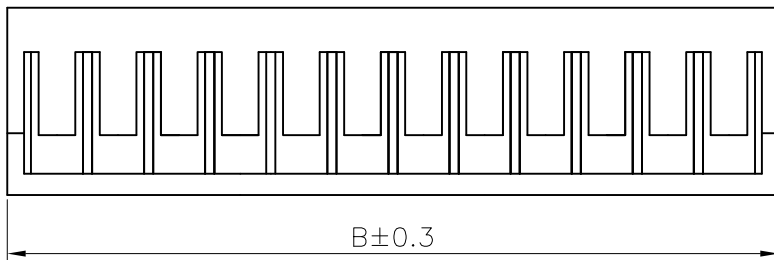

Recommended P.C.Board Layout

PART No.	Dimension mm	
	A	B
H2003V1020101A	2.00	5.20
H2003V1030101A	4.00	7.20
H2003V1040101A	6.00	9.20
H2003V1050101A	8.00	11.20
H2003V1060101A	10.00	13.20
H2003V1070101A	12.00	15.20
H2003V1080101A	14.00	17.20
H2003V1090101A	16.00	19.20
H2003V1100101A	18.00	21.40
H2003V1110101A	20.00	23.40
H2003V1120101A	22.00	25.40
H2003V1130101A	24.00	27.40
H2003V1140101A	26.00	29.40
H2003V1150101A	28.00	31.40
H2003V1160101A	30.00	33.40

MARK	REVISION DESCRIPTION	SIGNATURE	DATE	TOLERANCE	TITLE:	DRAWN:	CHECKED:	APPROVED:	REV.:	DRAWING NO.:
A3	Uniformly arrange the drawings	ZSZ	2021.09.06	X.X ±0.30	SAN2.0 180° Housing	ZSZ 2021.09.06			A3	2003HV01-A-S
A2	Change the part number and frame format	TLX	2020.03.28	X.XX ±0.20						
				X.XXX ±0.10						
				Angle ±2°	UNIT:mm	SCALE:N/A	SHEET:1/1	PROJECTION		

**KONNRA** 东莞市康瑞电子有限公司  
DongGuan Konnra Electronics Co.,Ltd.

PART NO.: H2003V1\*\*0101A

REV.: A3

**RoHS**  
COMPLIANT

◆ SPECIFICATIONS

- Current rating: 2A AC, DC
- Voltage rating: 250V AC,DC
- Temperature range: -40°C ~ +105°C
- Insulation resistance: 1000MΩ Min.
- Withstanding voltage: 800V AC/ minute.
- Contact resistance: 20mΩ Max.

Material: Nylon 66 UL 94V-0

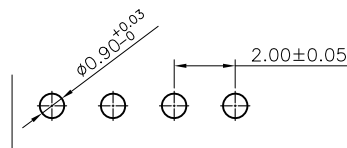
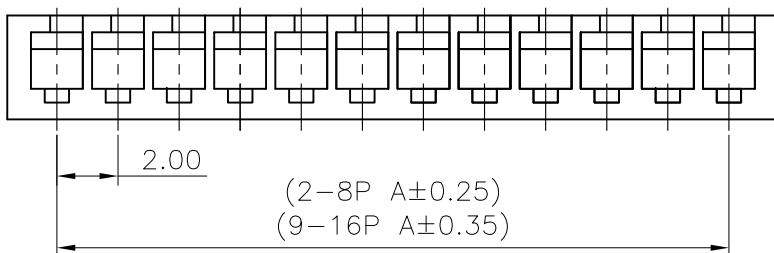
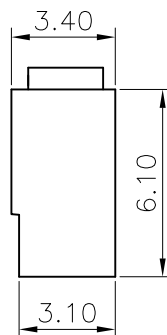
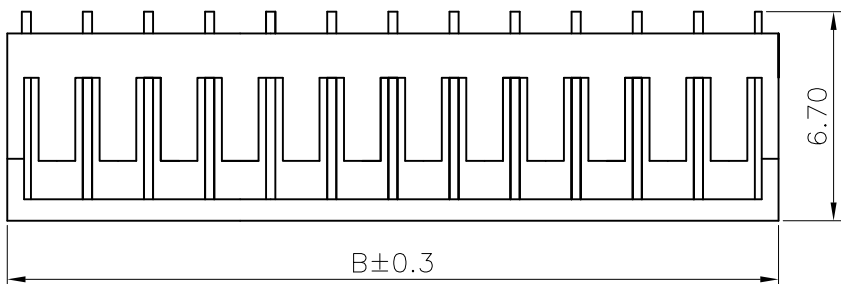

Recommended P.C.Board Layout

PART No.	Dimension mm	
	A	B
H2003R1020101A	2.00	5.20
H2003R1030101A	4.00	7.20
H2003R1040101A	6.00	9.20
H2003R1050101A	8.00	11.20
H2003R1060101A	10.00	13.20
H2003R1070101A	12.00	15.20
H2003R1080101A	14.00	17.20
H2003R1090101A	16.00	19.20
H2003R1100101A	18.00	21.40
H2003R1110101A	20.00	23.40
H2003R1120101A	22.00	25.40
H2003R1130101A	24.00	27.40
H2003R1140101A	26.00	29.40
H2003R1150101A	28.00	31.40
H2003R1160101A	30.00	33.40

MARK	REVISION DESCRIPTION	SIGNATURE	DATE	TOLERANCE	TITLE:	DRAWN:	CHECKED:	APPROVED:	REV.:	DRAWING NO.:
A5	Uniformly arrange the drawings	ZSZ	2021.09.06	X.X ±0.30	SAN2.0 90° Housing	ZSZ 2021.09.06			A5	2003HR01-A-S
A4	Change the part number and frame format	TLX	2020.03.28	X.XX ±0.20						
				X.XXX ±0.10		UNIT:mm	SCALE:N/A	SHEET:1/1	PROJECTION	
				Angle ±2°						

**KONNRA** 东莞市康瑞电子有限公司  
DongGuan Konnra Electronics Co.,Ltd.

PART NO.: H2003R1\*\*0101A

REV.: A5

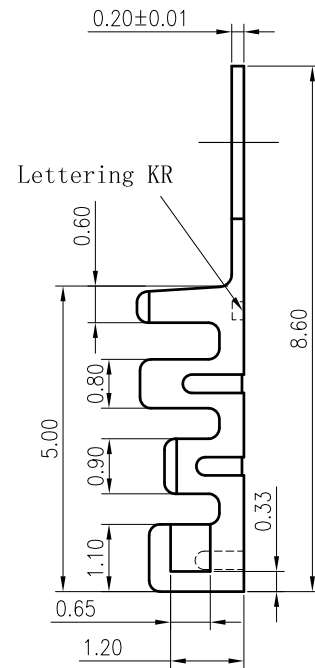
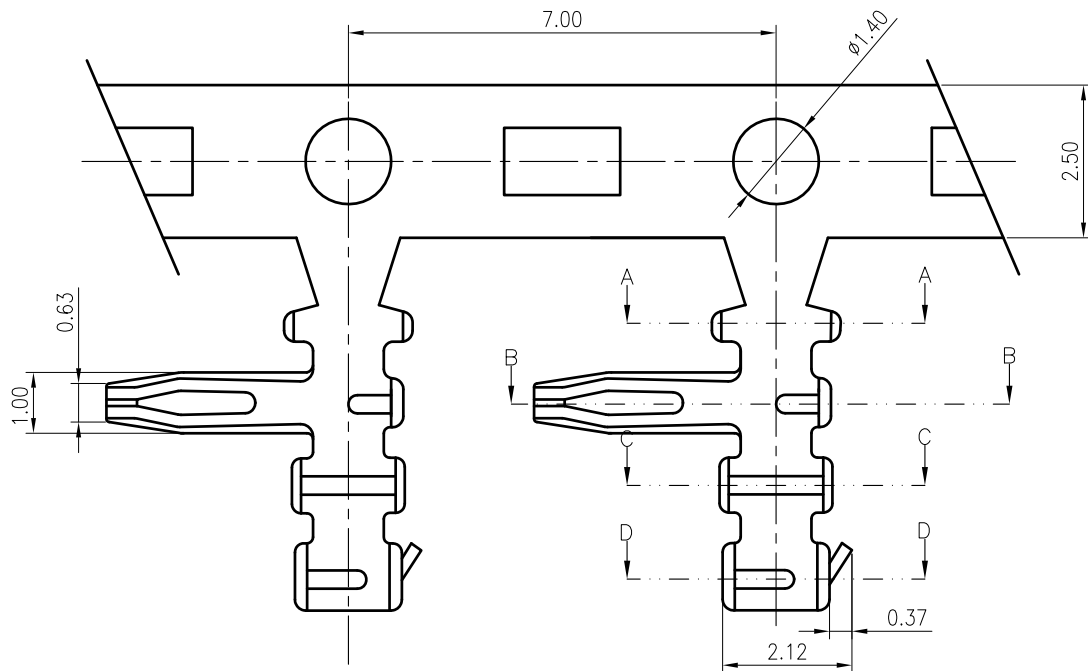

- ◆SPECIFICATIONS
- Current rating: 2A AC, DC
  - Voltage rating: 250V AC,DC
  - Temperature range: -40°C ~ +105°C
  - Insulation resistance: 1000MΩ Min.
  - Withstanding voltage: 800V AC/ minute.
  - Contact resistance: 20mΩ Max.

Material: Brass  
 Finish: Tin Plated over Nickel  
 Applicable wires:  
 AWG #24~#28  
 Insulation O.D.: 1.4mm Max.  
 Suitable: KR2003 series Housing  
 Qty/reel: 10,000PCS

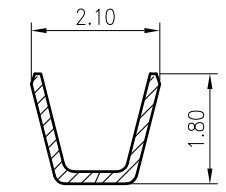

SECTION A-A

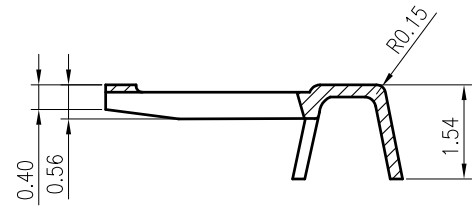

SECTION B-B

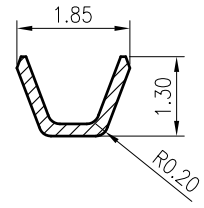

SECTION C-C

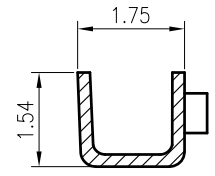

SECTION D-D

F		Uniformly arrange the drawings	ZSZ	2021.9.08	TOLERANCE X.X ±0.30 X.XX ±0.20 X.XXX ±0.10 Angle ±2°	TITLE: SAN2.0 90° Terminal		DRAWN: ZSZ 2021.9.08		KONNRA 东莞市康瑞电子有限公司	
		Improve the strength of soldering foot	ZZN	2021.4.29		UNIT:mm SCALE:1:1		CHECKED:		DongGuan Konnra Electronics Co.,Ltd.	
	MARK	VERSION RECORD	NAME	DATE		SHEET:1/1		APPROVED:		PART NO.: T2003RBT0101D	
	1	2	3	4		5	6	7	8	9	VER.:A5 DRAWING NO.:2003TR01-D-S

**RoHS**  
COMPLIANT

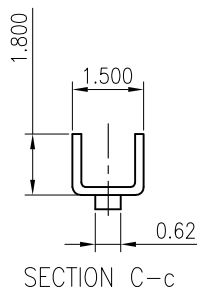
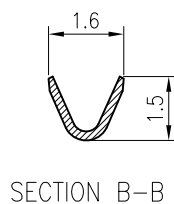
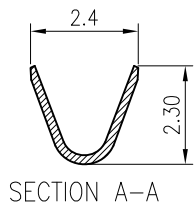
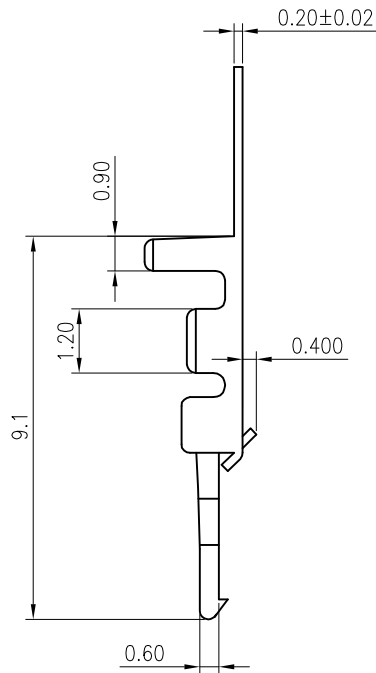
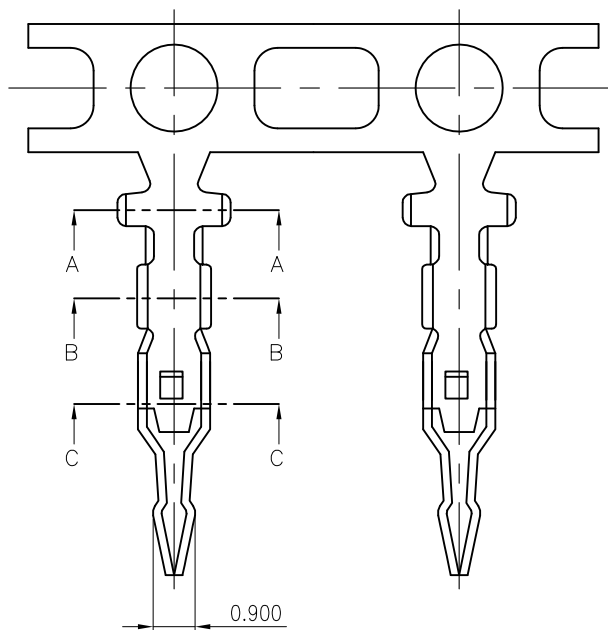

**SPECIFICATIONS**

1. Current rating: 2A AC, DC
2. Voltage rating: 250V AC,DC
3. Temperature range: -40°C ~ +105°C
4. Insulation resistance: 1000MΩ/ min.
5. Withstanding voltage: 800V AC/ minute.
6. Contact resistance: 20mΩ/ max.

Material: Brass

Plating: Tin plated over Nickel

Applicable wires:

AWG #24~#28

Insulation O.D.: 1.4mm Max.

Suitable KR2003 series housing

Q'ty/reel: 10,000PCS

				TOLERANCE		TITLE:		DRAWN: <i>ZSZ 2021.09.08</i>		KONNRA 东莞市康瑞电子有限公司	
F			Uniformly arrange the drawings	ZSZ	2021.09.08	X.X ±0.30	SAN2.0		CHECKED:		DongGuan Konnra Electronics CO.,LTD
			Change the part number and frame format	Arvin	2020.05.23	X.XX ±0.20	180° Terminal		APPROVED:		PART NO.: T2003VBT0101A
MARK		REVISION DESCRIPTION		SIGNATURE	DATE	X.XXX ±0.10	UNIT:mm	SCALE:N/A	SHEET: 1/1	PROJECTION	VER.: A2
1		2		3		Angle ±2°	4		5		6
7		8		9		DRAWING NO.: 2003TV101-A-S		9			