

RoHS
COMPLIANT

SPECIFICATIONS

1. Current rating: 1.5A AC, DC
2. Voltage rating: 100V AC, DC
3. Temperature range: -40°C ~ +105°C
4. Insulation resistance: 100MΩ/ min.
5. Withstanding voltage: 500V AC/ minute.
6. Contact resistance: 20mΩ/ max.

Material:

Insulator: PA9T UL 94V-0

Contact: Copper alloy

Nail: Copper alloy

Plating: 1um MIN Matte Tin plated over Nickel

Circuits: 2*4~2*20

Mates With KR1507 Series Dual Row Housing

Ordering Code: C1507VS2xx11M0101RA

204=2*4P

205=2*5P

R:REEL

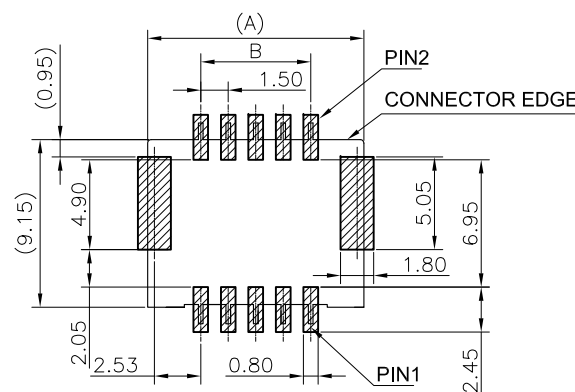
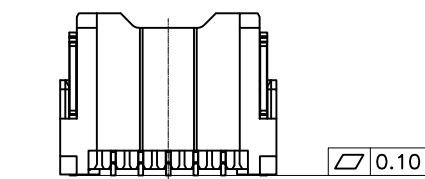
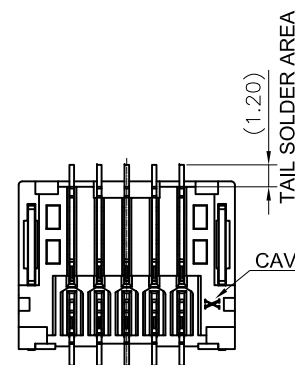
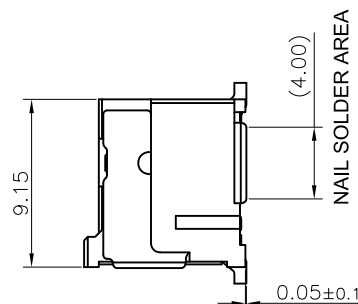
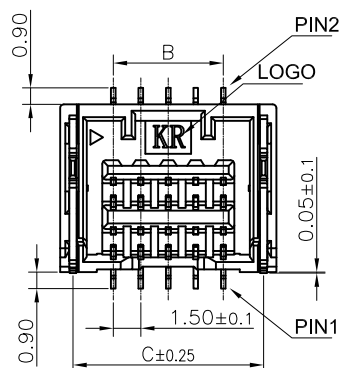
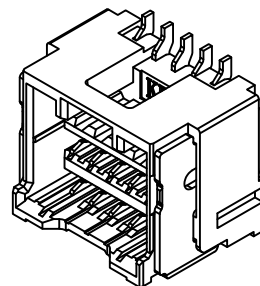
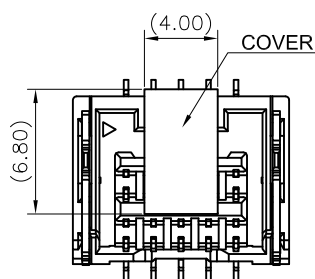
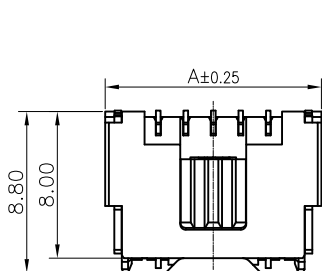

Recommended P.C.B. Layout
Total tolerance: ±0.05mm

Pin	Dimension		
	A	B	C
2*4P	10.30	4.50	8.93
2*5P	11.80	6.00	10.43
2*6P	13.30	7.50	11.93
2*7P	14.80	9.00	13.43
2*8P	16.30	10.50	14.93
2*9P	17.80	12.00	16.43
2*10P	19.30	13.50	17.93
2*11P	20.80	15.00	19.43
2*12P	22.30	16.50	20.93
2*13P	23.80	18.00	22.43
2*14P	25.30	19.50	23.93
2*15P	26.80	21.00	25.43
2*16P	28.30	22.50	26.93
2*17P	29.80	24.00	28.43
2*18P	31.30	25.50	29.93
2*19P	32.80	28.00	31.43
2*20P	34.30	28.50	32.93

F	A3				TOLERANCE	TITLE:	DRAWN: Shen 2022.05.10	KONNRA 东莞市康瑞电子有限公司 DongGuan Konnra Electronics Co.,Ltd. PART NO.: C1507VS2xx11M0101RA			
	A2				X.X ±0.30	MX1.5 INNER BUCKLE	CHECKED:				
	A1	NEW DWG	Shen	2022.05.10	X.XX ±0.20	DUAL ROW SMT 180°	APPROVED:				
MARK	REVISION DESCRIPTION	SIGNATURE	DATE	X.XXX ±0.10	Angle ±2°	UNIT:mm	SCALE:1/1	SHEET:1/2	PROJECTION	REV.:A1	DRAWING NO.:1507WVS201-A-S